

Service openings for green area

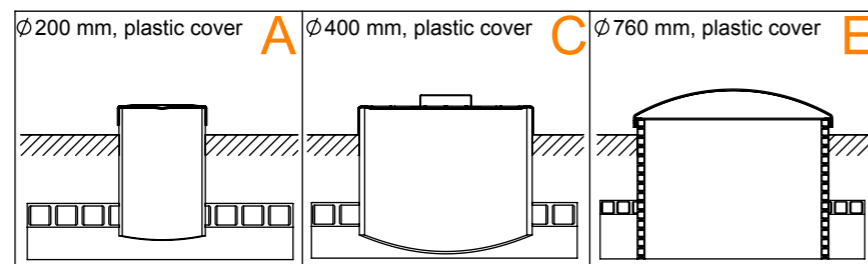

Service openings for asphalt area

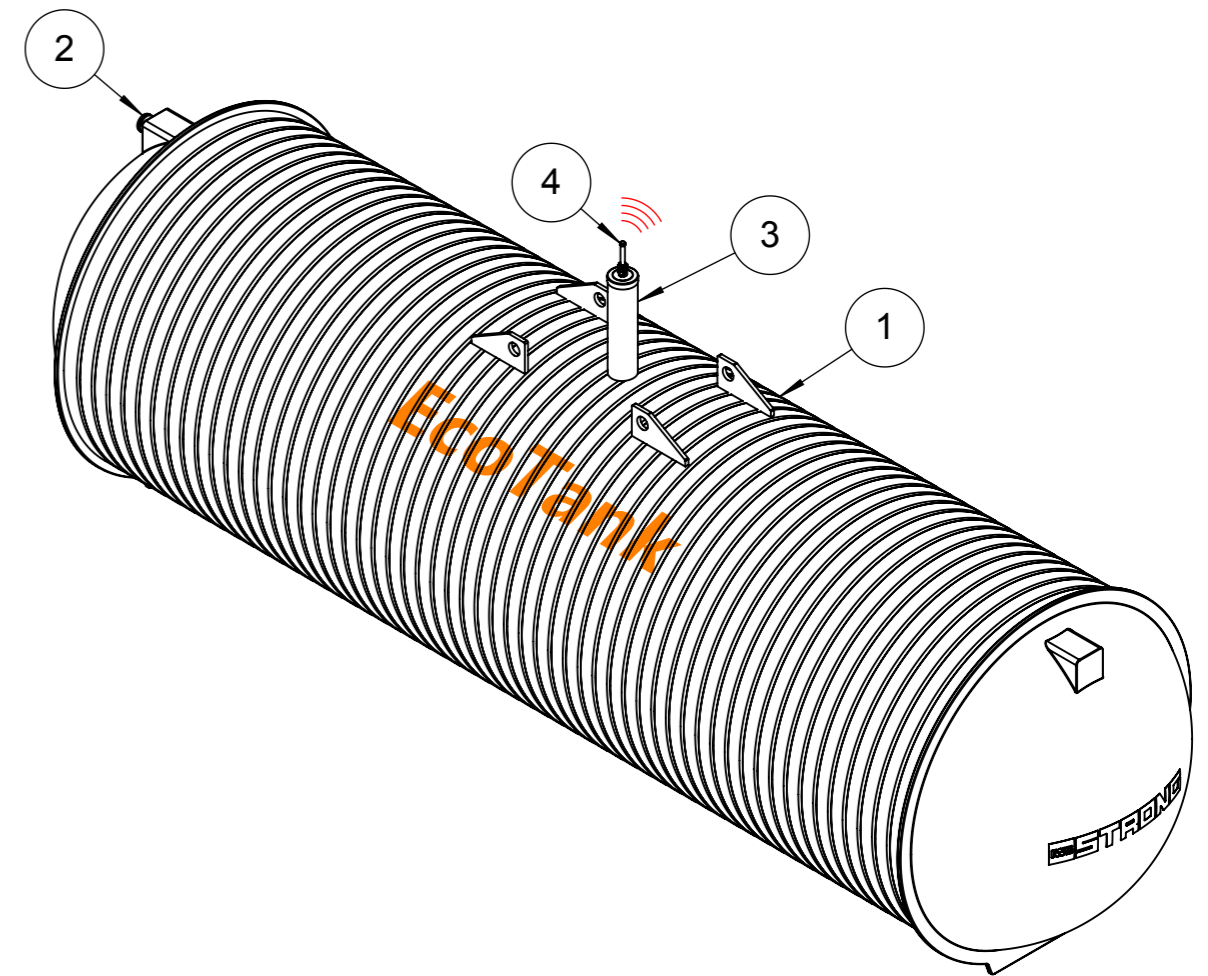
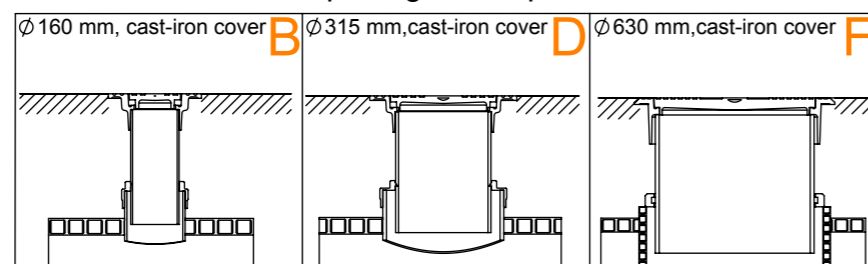

Service opening height : standard height 950 mm or h=..... mm
 Type of service opening: A B C D E F
 Service opening distance: standard in the center or L1=..... mm
 Inlet pipe diameter: d1=..... mm
 Alarm device: Yes No

No	Name	Material	Dimensions
1	Storage tank, double-wall pipe	PE	Ø 2600
2	Inlet pipe	PE	d1
3	Service opening	PE	
4	Alarm device Tank-Check RF-412		

Metric: mm 	Material: Unspec.	Finish: Unspec.	Mass: kg	Size: A3	Sheet: 1/1
Drawn: L.Roomet	STRONG Storage tank Ø 2400, 4000L				
Approved: M.Somelar					
EcoTank www.ecotank.fi				Drawing number: NA	